

# OEM VALVES MANIFOLDS DATASHEET



Elveflow OEM Valves manifolds splits up or merges liquid and gas. Two options available: a manifold 3 to 1 and a manifold 4 to 1. Compatible with the OEM 2/2 NC Low Pressure valves.

## Table of content

<b>General specifications</b> .....	<b>3</b>
<b>Dimensional drawing</b> .....	<b>4</b>
Manifold 3-1.....	4
Manifold only.....	4
Manifold with mounted valves.....	5
Manifold 4-1.....	5
Manifold only.....	5
Manifold and mounted valves.....	6

## General specifications

Manifold type	<b>Manifold 3-1</b>	<b>Manifold 4-1</b>
Dimensions manifold (mm)	<b>60 x 15 x 30 mm</b>	<b>72 x 15 x 30 mm</b>
Dimensions with valves (mm)	<b>60 x 72 x 30 mm</b>	<b>72 x 72 x 30 mm</b>
Weight (g)	<b>128 g</b>	<b>170 g</b>
Number of valves	<b>3</b>	<b>4</b>
Valves type	<b>OEM 2/2 NC Low Pressure valve</b>	<b>OEM 2/2 NC Low Pressure valve</b>
Valves connection type	<b>24V DC (2 wires)</b>	<b>24V DC (2 wires)</b>
Wetted materials	<b>PEEK, FKM</b>	<b>PEEK, FKM</b>
Maximum supported pressure (bar)	<b>2.5 bar</b>	<b>2.5 bar</b>
Fluidic connectors	<b>Standard 1/4-28 UNF, flat-bottom</b>	<b>Standard 1/4-28 UNF, flat-bottom</b>
Dead volume (1)	<b>None</b>	<b>None</b>
Internal diameter (mm)	<b>1 mm</b>	<b>1 mm</b>
Maximum internal volume (2)	<b>62 <math>\mu</math>L</b>	<b>72 <math>\mu</math>L</b>
Mounting orientation (3)	<b>Vertical recommended</b>	<b>Vertical recommended</b>

(1) Volume that is stuck in the system (dead end), which is not clearly swept and relies on diffusion to clear out.

(2) Volume inside the system from entrance to exit, taken from the common port to the furthest port for maximum.

(3) Since the body (orifice shape) is designed to eliminate residual liquid, mounting in a vertical direction with the coil at the top is recommended. When residual liquid is not considered, any mounting orientation is available.

# Dimensional drawing

(Dimensions in mm)

## Manifold 3-1

Manifold only

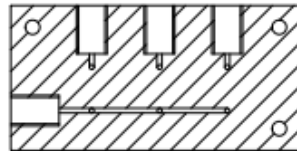

Section A-A

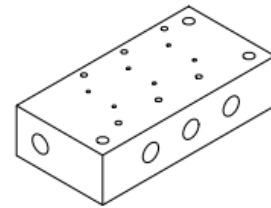
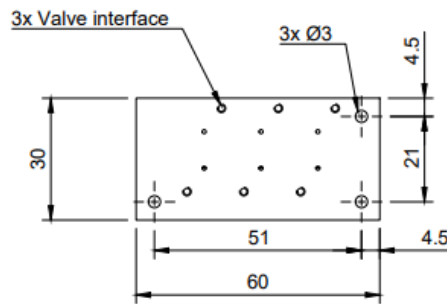
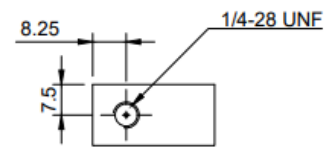
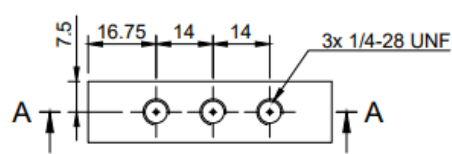

Manifold with mounted valves

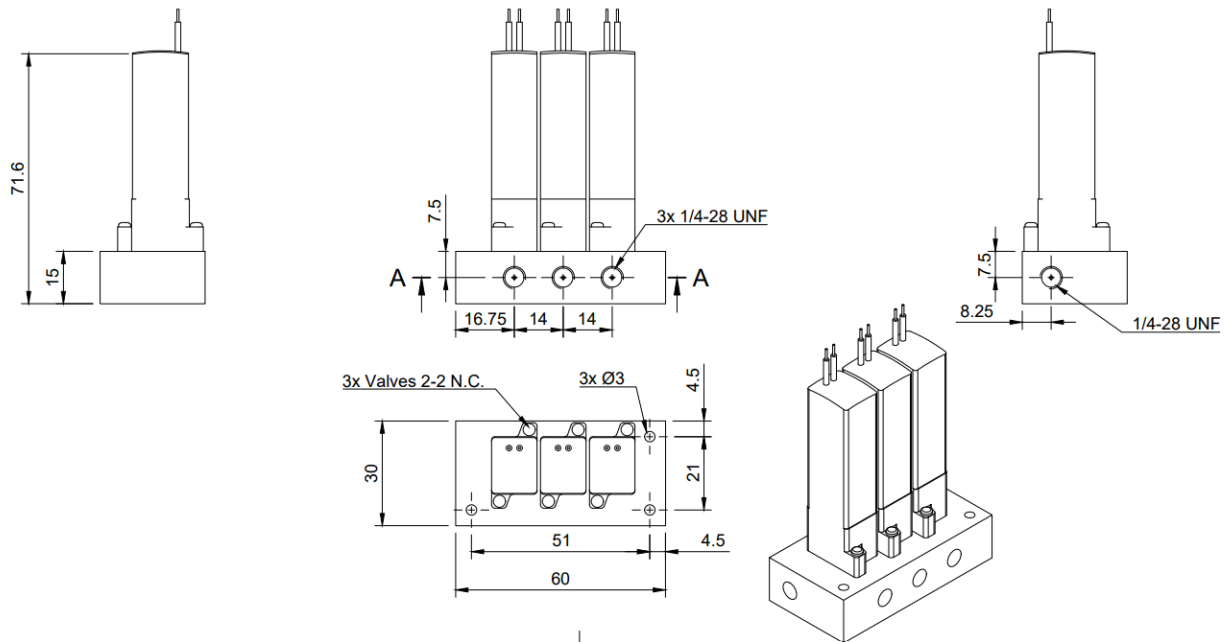

Manifold 4-1

Manifold only

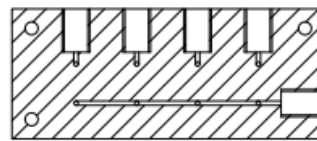

Section A-A

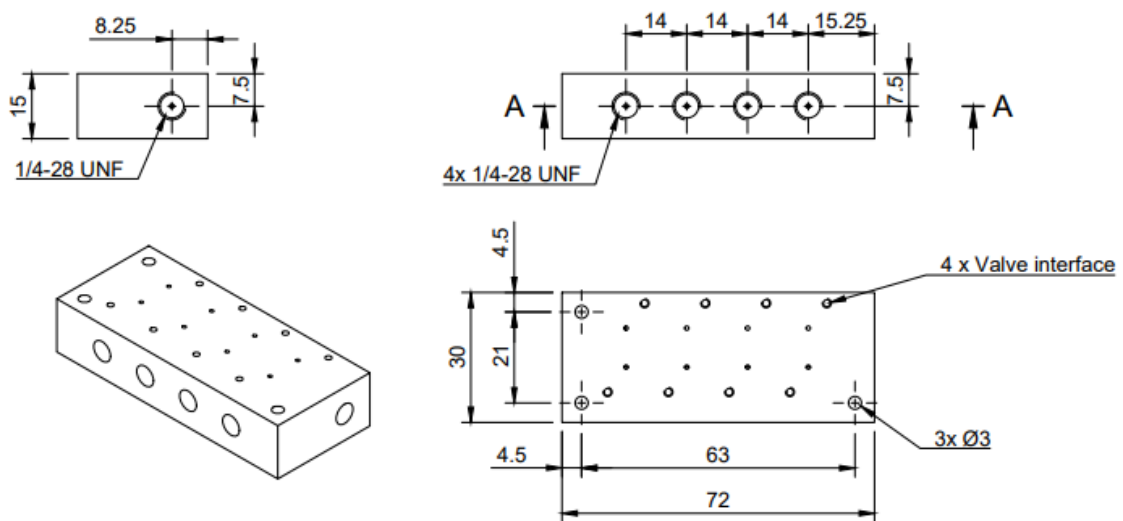

Manifold and mounted valves

